

# PRODUCT INFORMATION PACKET



Model No: 056C34F5301

Catalog No: D311

General Purpose Motor, 0.50 HP, 1 Ph, 60 Hz, 115/208-230 V, 3600 RPM, 56C Frame, TEFC

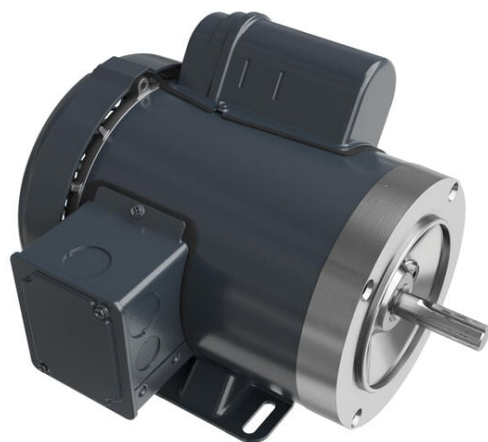

Regal and LEESON are trademarks of Regal Rexnord Corporation or one of its affiliated companies.  
©2025 Regal Rexnord Corporation, All Rights Reserved. MC017097E





### Nameplate Specifications

Phase	1	Output HP	0.50 Hp
Output KW	0.37 kW	Voltage	115/208-230 V
Speed	3450 rpm	Service Factor	1.15
Frame	56C	Enclosure	Totally Enclosed Fan Cooled
Thermal Protection	No Protection	Efficiency	59.5 %
Ambient Temperature	40 °C	Frequency	60 Hz
Current	8.4/4.0-4.2 A	Power Factor	70
Duty	Continuous	Insulation Class	B
Design Code	N	KVA Code	N
Drive End Bearing Size	6203	Opp Drive End Bearing Size	6203
UL	Recognized	CSA	Y
CE	Y	IP Code	43
Number of Speeds	1		

### Technical Specifications

Electrical Type	Capacitor Start Induction Run	Starting Method	Across The Line
Poles	2	Rotation	Selective Counterclockwise
Resistance Main	0 Ohms	Mounting	Bolt-on Base
Motor Orientation	Horizontal	Drive End Bearing	Ball
Opp Drive End Bearing	Ball	Frame Material	Rolled Steel
Shaft Type	NEMA 56	Overall Length	11.81 in
Frame Length	6.56 in	Shaft Diameter	0.625 in
Shaft Extension	2.06 in	Assembly/Box Mounting	F1 ONLY
Outline Drawing	A-100143-656	Connection Drawing	102005-51

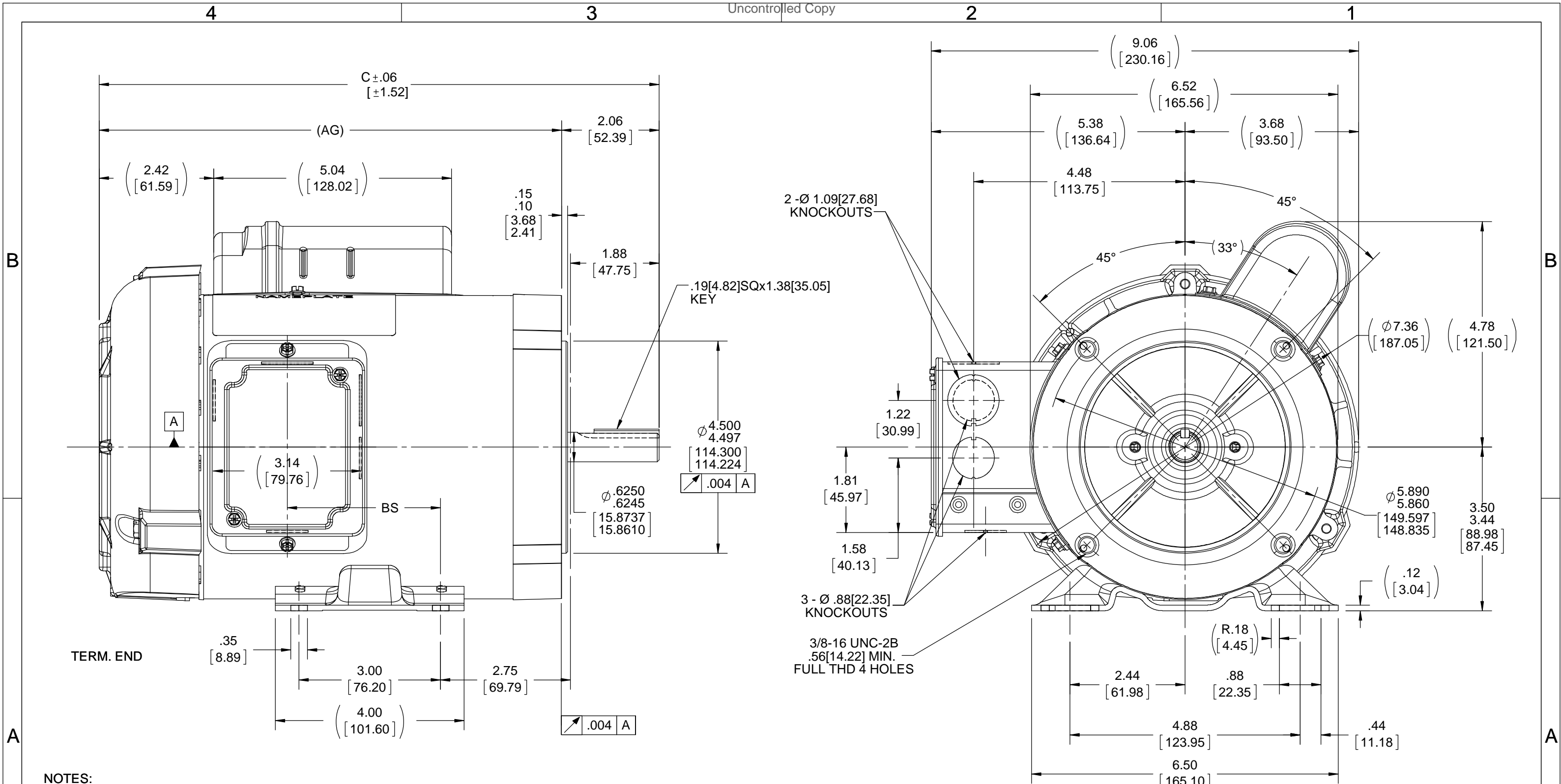

NOTES:  
 1.CONDUIT BOX CAN BE ROTATED 180°.  
 2.REMOVABLE BASE.  
 3.NAMEPLATE READ FROM COND. BOX SIDE OF MOTOR.

DASH	C	AG	BS
656	11.86 [301.24]	9.80 [248.92]	3.25 [82.55]
706	12.36 [313.94]	10.30 [261.62]	3.75 [95.25]
756	12.86 [326.64]	10.80 [274.32]	4.25 [107.95]

DRAWING REVISION G	REVISION BY H. ADIKE	DATE 8-23-2018
ECO ECO-0152983	APPROVED BY JD	DATE 9-20-2018
ECO DESCRIPTION OUTLINE CONVERSION PROJECT		
<small>COPYRIGHT REGAL BELOIT AMERICA, INC. ALL RIGHTS RESERVED.                  PROPRIETARY AND CONFIDENTIAL INFORMATION - THIS DOCUMENT IS THE PROPERTY OF                  REGAL BELOIT AMERICA, INC. ("OWNER") AND CONTAINS OWNER'S PROPRIETARY                  INFORMATION. ANY PERSON, CORPORATION OR OTHER FIRM RECEIVING IT IS DEEMED,                  BY RECEIVING IT, TO AGREE THAT IT, AND/OR ANY PART OF IT, SHALL NOT BE DISCLOSED                  TO ANY PERSON, CORPORATION OR OTHER ENTITY, DUPLICATED, AND/OR USED, EXCEPT                  AS EXPRESSLY APPROVED IN WRITING IN ADVANCE BY OWNER. THIS DOCUMENT SHALL                  BE RETURNED TO OWNER UPON REQUEST. IT MAY BE SUBJECT TO CERTAIN                  RESTRICTIONS UNDER APPLICABLE EXPORT CONTROL LAWS AND REGULATIONS.</small>		

TOLERANCES UNLESS OTHERWISE SPECIFIED:			
DEC.	INCH	mm	ANGLE
.X	±0.1	[±2.5]	±7° 30'
.XX	±0.03	[±0.76]	
.XXX	±0.005	[±0.127]	
.XXXX	±0.0005	[±0.0127]	
REMOVE BURRS & BREAK SHARP EDGES: .003/.015 [.076/.381] X 45°			
CORNER FILLETS: R.02 [.51]			
MACHINED SURFACES: 200 INCH/mm 5.1			
mm SHOWN IN [BRACKETS]			

DRAWN BY BLR	DATE 05-28-1997
APPROVED BY GK	DATE 06-03-1997
REFERENCE 100143	THIRD ANGLE PROJECTION

Regal Beloit America, Inc.	
DESCRIPTION OUTLINE	
56 FR. -BB - TEFC - 1Ø - 'C' FACE	
MATERIAL	PROCESS/FINISH
SIZE B	DRAWING NUMBER 100143
SHEET 1 OF 1	

LOW VOLTAGE - C.C.W.

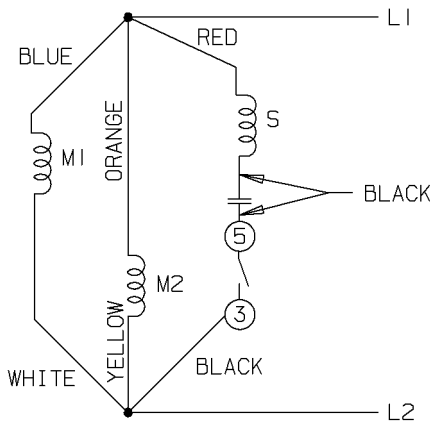

HIGH VOLTAGE - C.C.W.

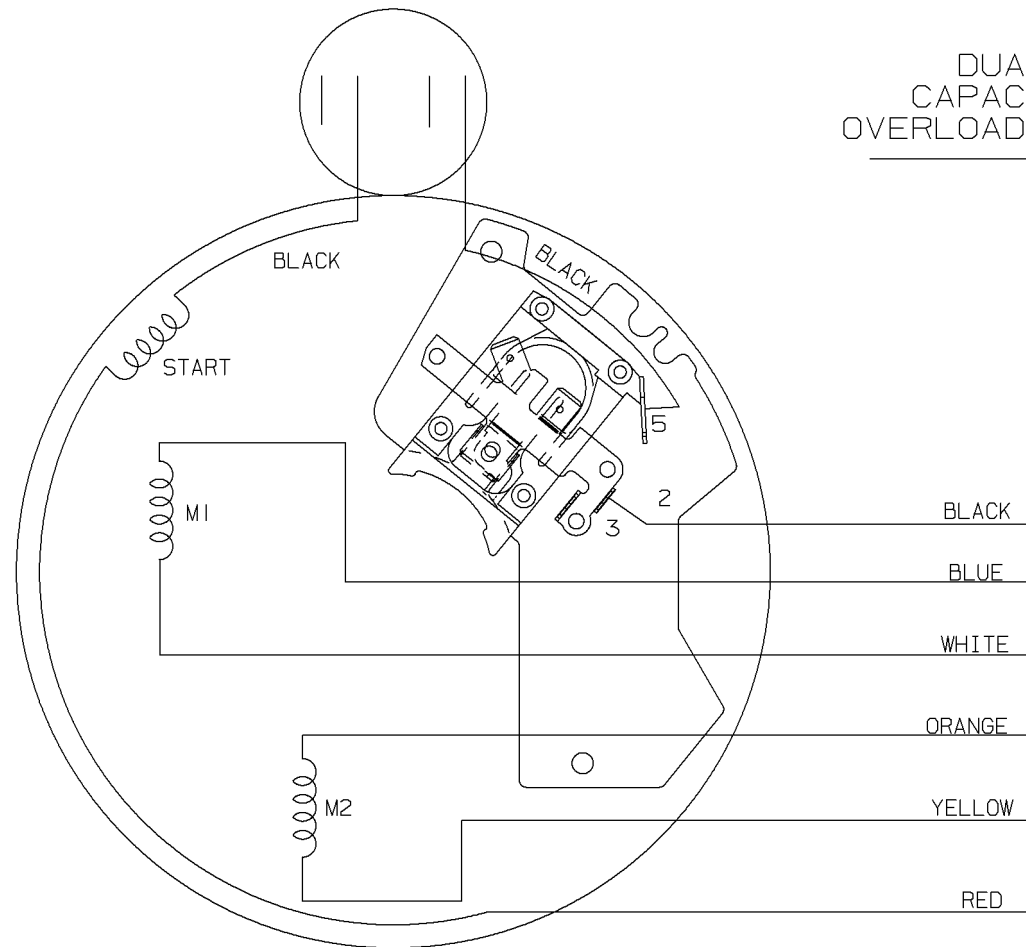
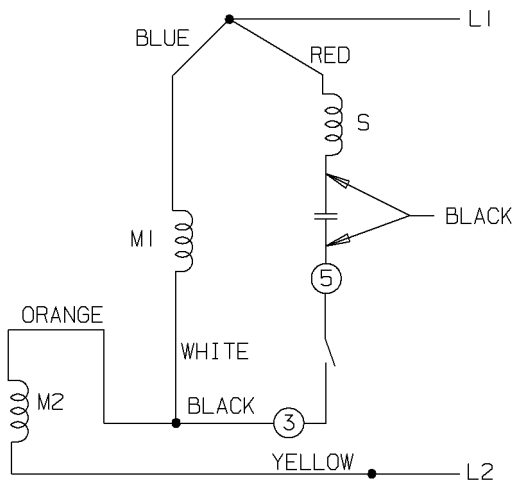

DUAL VOLTAGE  
CAPACITOR START NO  
OVERLOAD SELECT ROTATION

LOW VOLT. - C.C.W. ROT.

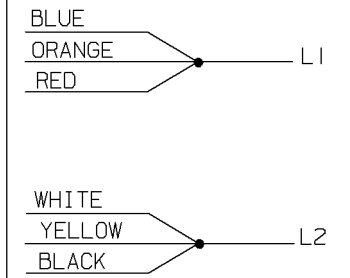

HIGH VOLT. - C.C.W. ROT.

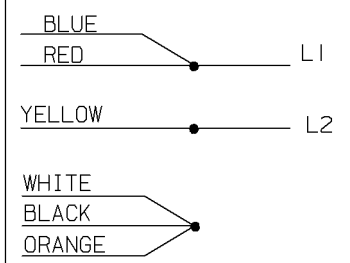

FOR C.W. ROTATION EITHER  
VOLTAGE INTERCHANGE  
RED WITH BLACK LEAD

				✓ MAX. SURFACE ROUGHNESS UNLESS NOTED OTHERWISE	UNLESS OTHERWISE SPECIFIED DIMENSIONS ARE IN INCHES TOL. ON XX±    XXX±.005    XXXX±.0005    ANGLES±			
6	KVDG	CHD FROM MARATHON TO REGAL REXNORD LOGO	DS	MATL SPEC	 Regal Beloit America, Inc.	DRAWN BY	CAV	06-18-1999
5	06-17-1999	REDRAWN	CAV	FINISH		CHKD BY	ML	06-18-1999
				REFERENCE DRW.		APPD BY	GK	06-18-1999
REV	DATE	CHANGE	NAME	PART NAME CONNECTION DIAGRAM			DRWG NO A-102005-51	

SHOP BOOK

PURCHASED

DISTRIBUTION - WA - LB - WP - LM - BR

CADD FILE NO.

102005-51





**REGAL REXNORD CORPORATION**  
 TYPICAL PERFORMANCE CURVE for AC MOTOR

Customer \_\_\_\_\_ Curve at 230 Volts HP 0.50 PHASE 1  
 Model No 56C34F5301 60 HZ  
0.5 HP VOLTS 115/208-230  
 Catalog No D311 HZ 60 RPM 3450

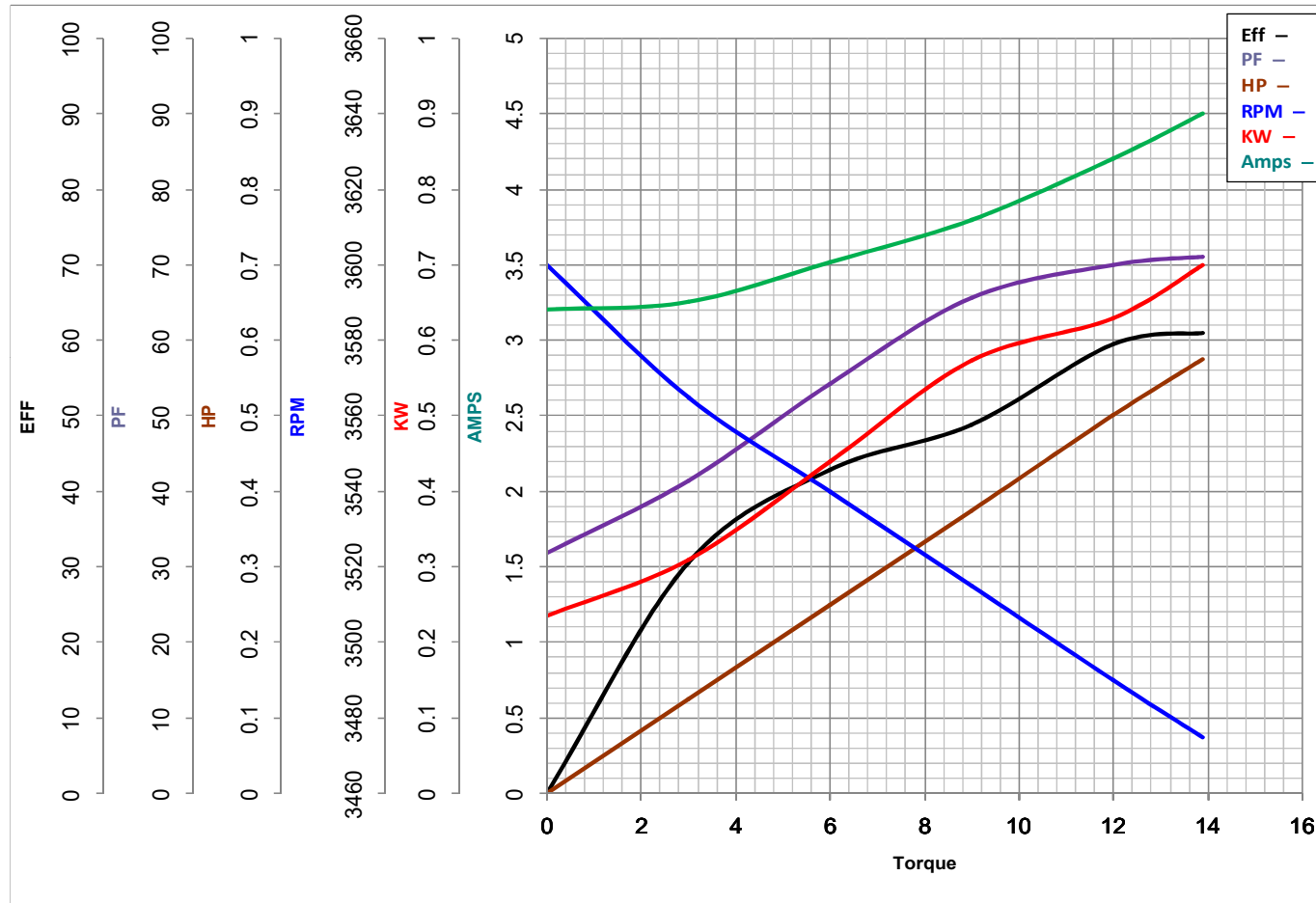

				Torque in Oz.Ft	
FL TORQUE	<u>12</u>	Oz.Ft	FL AMPS	<u>8.4/4-4.2</u>	
BD TORQUE	<u>35.5</u>	Oz.Ft	PU TORQUE	<u>32.0</u>	Oz.Ft
LR TORQUE	<u>45</u>	Oz.Ft	LR AMPS	<u>24.5</u>	
WINDING	ZC280-3		Date	1/11/2019	

## EC Declaration of Conformity

The undersigned representing  
the manufacturer:

Regal Beloit America  
1946 West Cook Road  
Fort Wayne, IN 46818

and the authorized representative  
established within the Community:

Regal Beloit Italy  
Via Modena, 18  
24040 Ciserano(BG) - Italy

are committed to providing customers with products that comply with applicable regulations and international protocols to which they are subject, including the requirements of the European Parliament Directive on the Harmonization of the laws relating to electrical equipment designed for use within certain voltage limits (2014/35/EU).

Regal Beloit America declares that the following product(s), to which this declaration relates, are in conformity with the relevant sections of the EC standards listed below.

This statement supersedes any statements previously issued pertaining to the product(s) listed below and is subject to change without notice.

Model No : 056C34F5301

(Model No. may contain prefix and/or suffix characters)

Catalog No : D311

Rework No : N/A

Directives :

Low Voltage Directive 2014/35/EU

Harmonized Standards Used :

EN 60034-1: 2010 (IEC 60034-1: 2010)

EN 60034-5: 2001/A1:2007 (IEC 60034-5: 2000/A1:2006)

Authorized Representative:



Zach Stauffer  
Vice President, Engineering

Authorized Representative in the Community:



Stefano Casiraghi  
Technology Director, Engineering

Created on 07/08/2025

**CE 25**