

PRODUCT INFORMATION PACKET

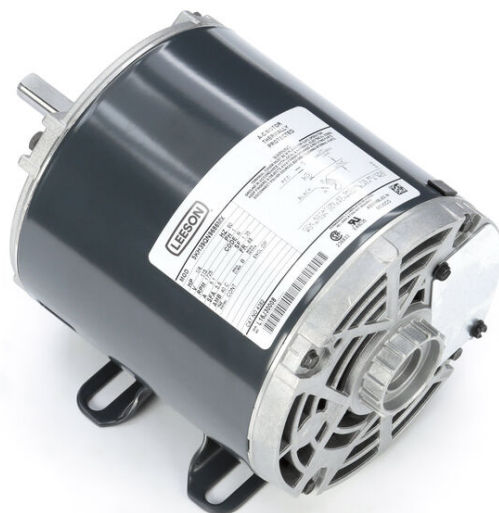

Model No: 5KH39QN9686X
Catalog No: 4362
General Purpose Motor, 1/4 HP, 1 Ph, 60 Hz, 115 V, 48 Frame, DP



Regal and LEESON are trademarks of Regal Rexnord Corporation or one of its affiliated companies.
©2025 Regal Rexnord Corporation, All Rights Reserved. MC017097E





Nameplate Specifications

Phase	1	Output HP	1/4 Hp
Output KW	0.19 kW	Voltage	115 V
Speed	1725 rpm	Service Factor	1.35
Frame	48	Enclosure	Drip Proof
Thermal Protection	Automatic	Ambient Temperature	40 °C
Frequency	60 Hz	Current	5.1 A
Power Factor	0	Duty	Continuous
Insulation Class	B	KVA Code	R
Drive End Bearing Size	6203	Opp Drive End Bearing Size	6203
UL	Recognized	CSA	Y
CE	N		

Technical Specifications

Electrical Type	Split Phase	Starting Method	Across The Line
Poles	4	Rotation	Selective Counterclockwise
Motor Orientation	Any	Drive End Bearing	Ball
Opp Drive End Bearing	Ball	Frame Material	Rolled Steel
Shaft Type	NEMA 48	Shaft Diameter	0.500 in
Outline Drawing	52A106959P1	Connection Drawing	52A105379AA

This is an uncontrolled document once printed or downloaded and is subject to change without notice. Date Created:11/13/2025



SHEET —	THIRD ANGLE PROJECTION	REVISIONS			
		REV.	DESCRIPTION	DATE	APPROVED
REV 4		3	REDRAWN & ADDED P7	09/09/93	MAM
		4	CHG TO RBC FORMAT PER ISO5-1777	02/15/06	SUDHA

SIZE
DRAWING NO.
A

52A106959

W* IS A CLEARANCE DUE TO VARIATION IN PARTS AND ASSEMBLY.

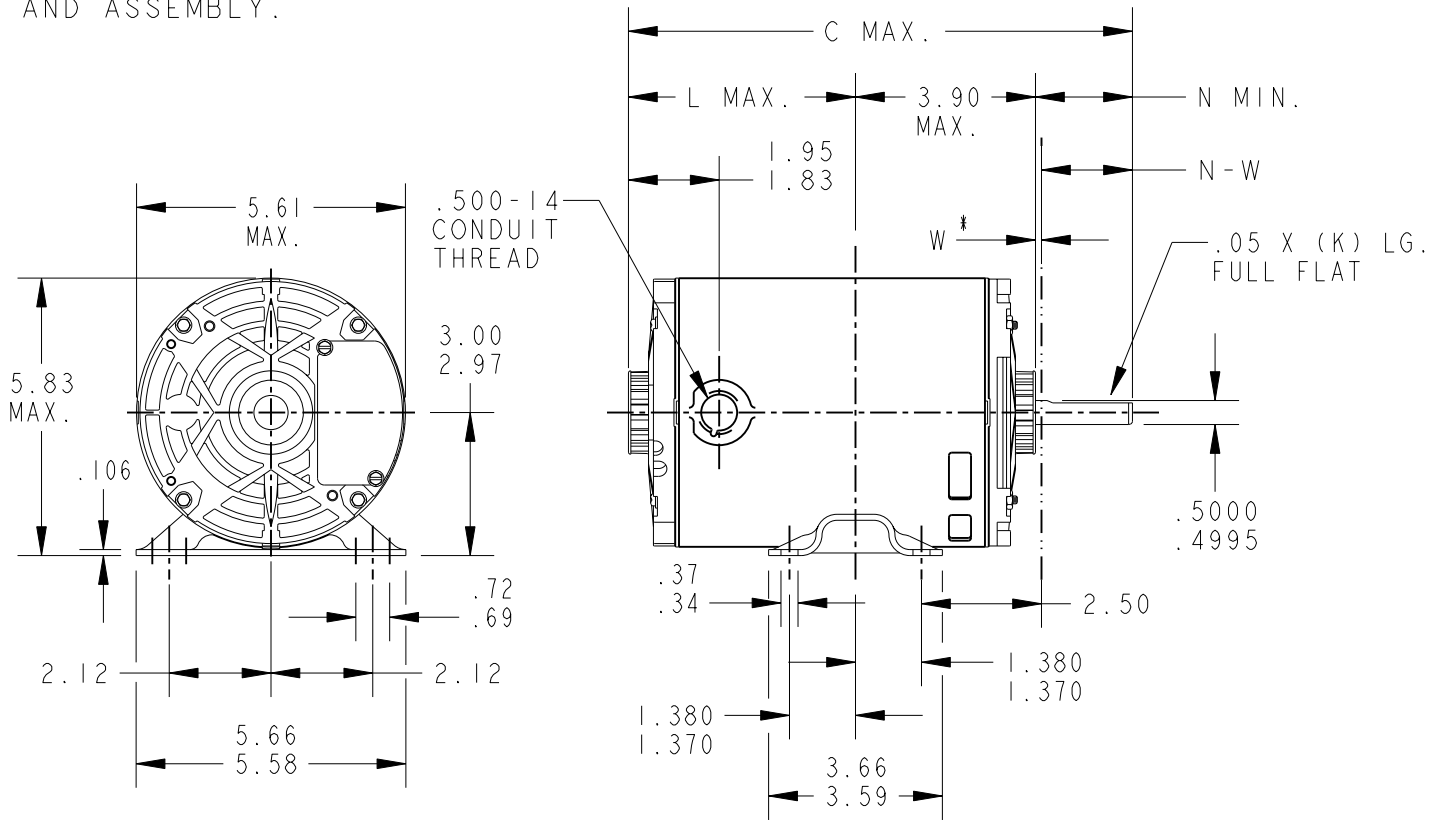

7	KH	33	48	9.00	1.34	3.84	1.88	2.01/1.79
6	KH	32	48	8.62	1.16	3.27	1.50	1.63/1.41
5	K KH	37	48	10.40	1.16	5.05	1.50	1.63/1.41
4	K KH	36	48	10.00	1.16	4.65	1.50	1.63/1.41
3	K KH	35	48	9.57	1.16	4.22	1.50	1.63/1.41
2	K KH	33	48	9.19	1.16	3.84	1.50	1.63/1.41
1	K KH	32	48	8.94	1.16	3.59	1.50	1.63/1.41
P	TYPE	GE SIZE	NEMA FR	C	K	L	N	N-W

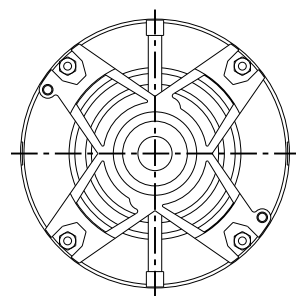

VIEW SHOWING P.E. VENTILATION OPENINGS

FOR ADDITIONAL INFO REFER TO: APPLIED PRACTICES DIMENSIONS ARE IN INCHES ✓ MATERIAL	SIGNATURES	DATE	<p>REGAL-BELOIT CORPORATION</p> <p>TITLE OUTLINE</p> <p>FORM N - GENERAL PURPOSE MOTOR - DRIP PROOF - WELDED BASE - BALL OR SLEEVE BEARING</p> <p>SCALE: 0.250 REF. No: .</p>
	MODEL	MAM 06/15/89	
	DETAIL	.	
	CHECKED	.	
	ENGRG	.	
MFG	.		
QUALITY	.	SIZE	DRAWING
ISSUED	MAM 09/09/93	A	
SOLID MODEL: 52A106959			

52A106959 REV 4

SHEET 1 of 1



SHEET 6
REV 6
52A105379AA
SIZE DRAWING NO. A

THIRD ANGLE PROJECTION

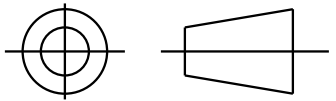

REVISIONS

REV.	DESCRIPTION	DATE	APPROVED
6	UPDATED FORMAT	12/01/05	MAM

EITHER ROTATION-SINGLE VOLTAGE-TYPE KC OR KH-WITH THERMAL PROTECTOR

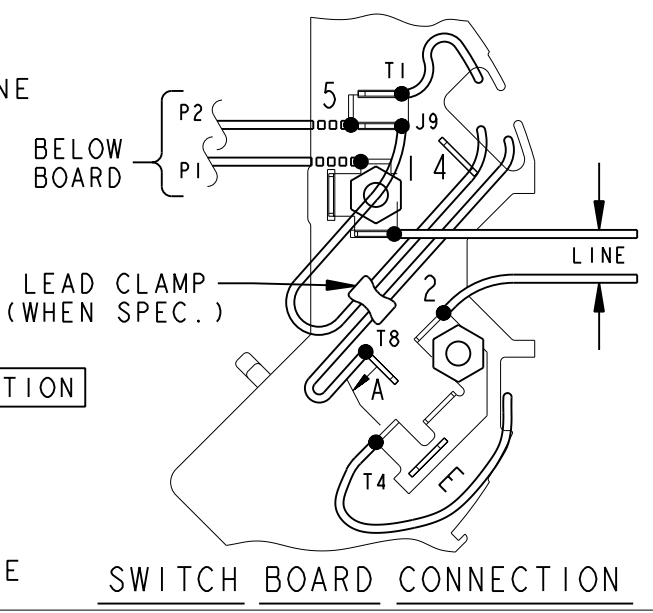
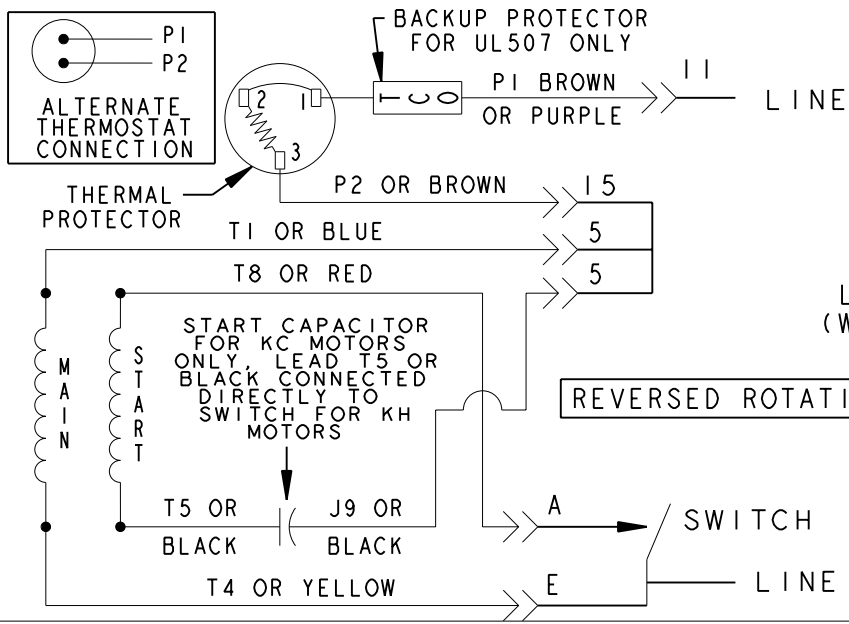
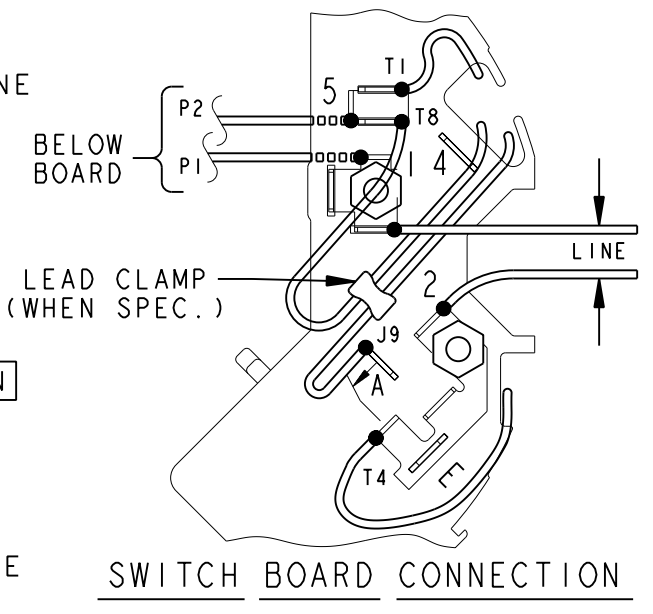
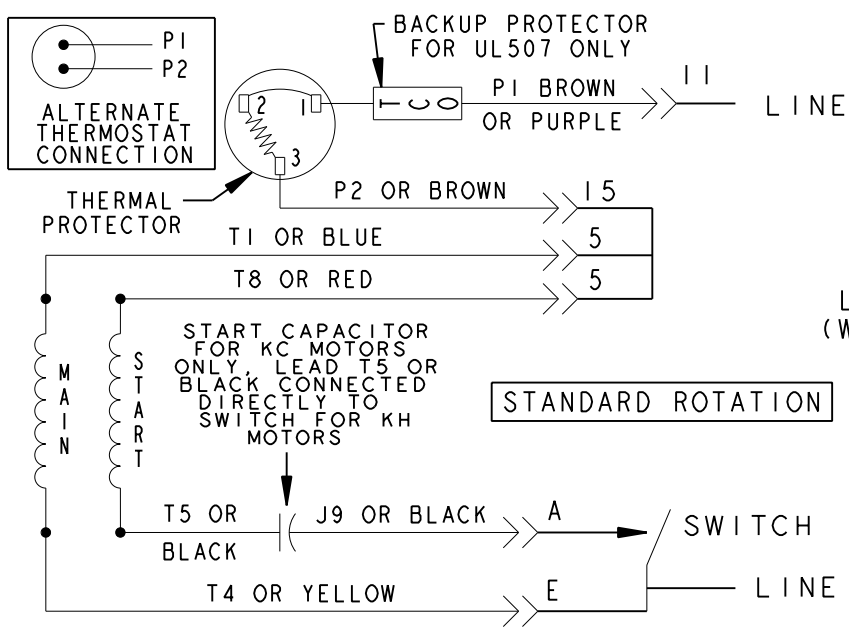

NOTE #1 - TO REVERSE ROTATION INTERCHANGE RED (T8) AND BLACK (J9-KC OR T5-KH) LEADS.
NOTE #2 - WHEN MORE THAN ONE CAPACITOR IS USED CONNECT IN PARALLEL.

SWITCH (C) - 115D958AB REF. DIAG. - 121A851 CONN. LABEL - 52X332048

SIGNATURES		DATE
MODEL	M. D. PAPE	06/29/87
DETAIL	.	.
CHECKED	.	.
ENGRG	.	.
MFG	.	.
FOR ADDITIONAL INFO REFER TO:	QUALITY	.
APPLIED PRACTICES	ISSUED	M. D. P. 03/08/00
DIMENSIONS ARE IN INCHES ✓	SOLID MODEL: 52A105379AA	

REGAL-BELOIT CORPORATION

CONNECTION DIAGRAM

FMF - 30 FR SWITCH REDESIGN

SIZE DRAWING: A

SCALE: 1.000 REF. No: .

52A105379AA REV 6

SHEET 1 of 1